



ILE CLUB

design Piero Lissoni

Elements with different dimensions with armrest and backrest structure in double-paneled poplar and pine. Seat chassis in lacquered steel with coated rubber elastic straps. Frame padding in Visco-Soft and differentiated density polyurethane, covered with a mat in prewashed and sterilized goose down, stitched into separate compartments, or covered with acrylic fibre layers. Seat cushions padding in differentiated density polyurethane foam and Visco-Soft, covered with a mat in prewashed and sterilized

goose down, stitched into separate compartments, or covered with acrylic fibre layers. Under seat panel in thermobounded rigid wadding, 100% polyester. AISI 304 Stainless Steel base with matt satin-finish or in steel lacquered in gunmetal grey colour or burnished colour. Fabric or leather upholstery, both fully removable by zippers and Velcro fastenings. On request quilted seat cushions available, non-removable leather upholstery. Seat depth: 66cm.

Base



Burnished
Painted Steel



Stainless Steel
with Matt Satin
Finish

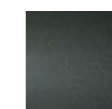

Steel with
Gunmetal Grey
Coating

Notes

On request version in fabric with profile in "gros grain" standard to match; version in leather with profile in the same leather. For sofa with leather upholstery, the profile is always in the same finishing.

On request, quilted seat cushion available: removable only with fabric upholstery; with central stitching in the leather version.

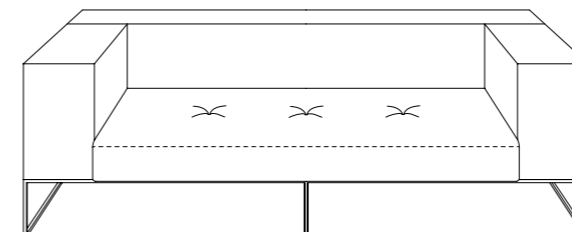

For composition with different elements, please attach a general sketch to the order.

Technical Drawings

Sofa

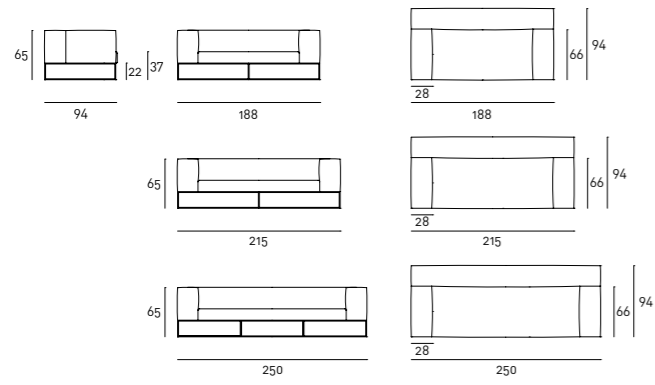

Terminal Element

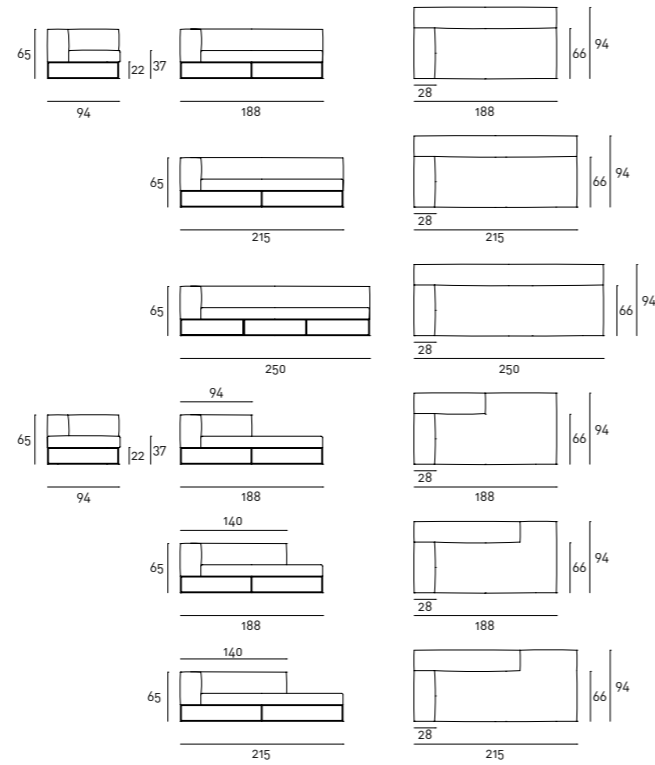

Central Element

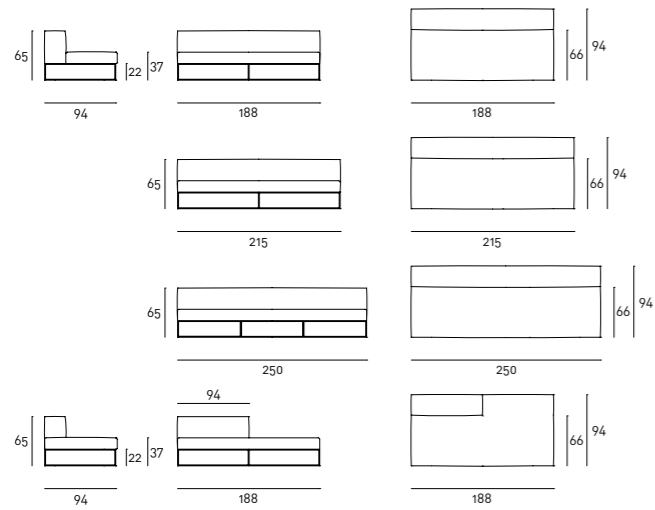

Bench

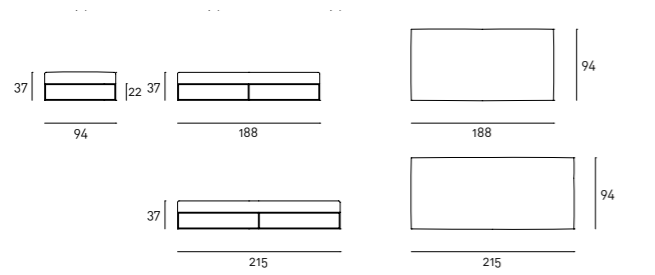

Loose Cushion

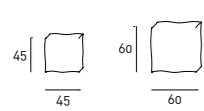

Examples of Composition

Composition 01

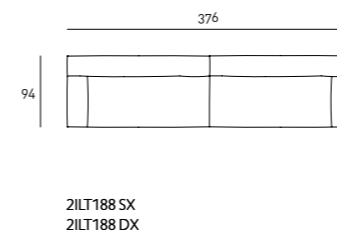

Composition 02

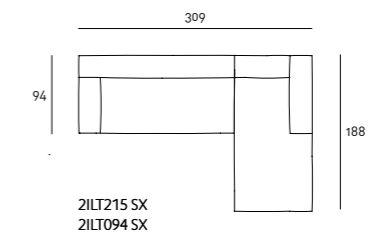

Composition 03

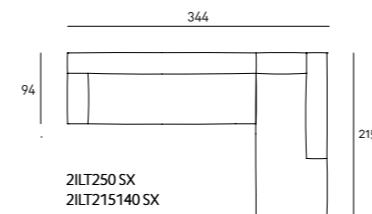

Composition 04

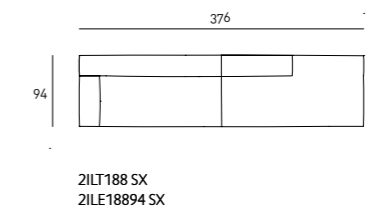

The commercial codes refer to the elements chosen in the above-proposed compositions.

